



VEGA 50





# VEGA 50

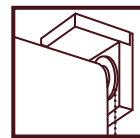

## FINITURE / FINISHES

67 = alluminio lucido  
bright aluminium

25 = alluminio colore acciaio satinato  
aluminium - satined steel color

65 = oro opaco  
mat gold



67



25



65

IN COPERTINA MODELLO NELLA FINITURA ALLUMINIO COLORE ACCIAIO SATINATO  
IN COVER MODEL IN ALUMINIUM - SATINED STEEL COLOR

## TANGERI collection

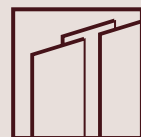
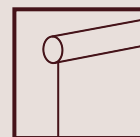

Codice tessuto / Fabric reference	<b>JM420079</b>		
Composizione / Basic material	100 % poliestere / 100 % polyester	Tessuto ignifugo / Flame-retardant	No
Finitura / Finishing	Finitura rigida / Stiff finish	Adatto per ambienti umidi / Suitable for moist atmosphere	No
		Adatto per uffici / Suitable for office environment	Limitato/Limited

Larghezza finale / Final width		200 cm
Peso tessuto / Fabric weight		~ 195 g/m <sup>2</sup>
Spessore / Thickness DIN EN ISO 5084		~ 0,36 - 0,40 mm
Alterazione dei colori alla luce: lato finestra / Light fastness: window-side DIN ISO 105 – B02	tasso / rating	≥ 5-6 in base al colore / dep. on colour
Solidità sfregamento: a secco / Rubbing fastness: dry DIN ISO 105 – X12	tasso / rating	≥ 3-4 in base al colore / dep. on colour
Restringimento umidità: (%) conforme a DIN 53892 B 2 / Moisture shrinkage: (%) according to DIN 53892 B 2	ordito / warp trama / weft	< 0,5 < 0,5
Fattori termici e ottici / Thermal and optical factors		In base al colore (vedere scheda specifica) / Depending on colour (see specific card)
Consigli per la manutenzione / Care instruction		Rimuovere la polvere con un aspirapolvere o con l'aria compressa. Non sfregare. Non usare solventi o sostanze abrasive che danneggiano il tessuto. Pulire con una spugna o una spazzola insaponata. Sciacquare con acqua pulita. Asciugare. Remove dust with vacuum cleaner or compressed air. Do not scrub. Do not use solvents or any abrasive substance that might damage the coating of fabric. Clean with a sponge or soft brush dipped in soapy water. Rinse with clear water. Leave the blind until completely dry.

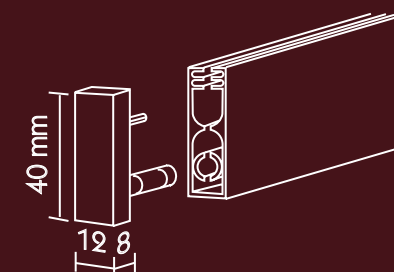
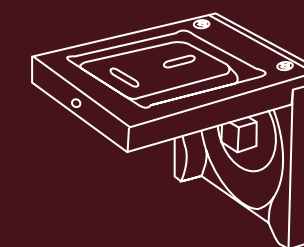
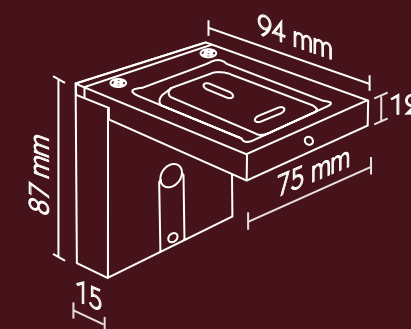
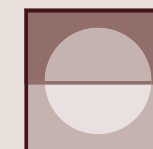

I dati forniti sono valori medi e sono soggetti a variazioni entro le tolleranze utilizzabili.  
All details are only average values and are subject to change within usable tolerances.



### INFORMAZIONI AMBIENTALI

Tessuto fabbricato senza l'aggiunta di sostanze dannose alla salute come formaldeide, CFC, solventi, componenti di piombo, cadmio, mercurio.  
Prodotto senza PVC. Certificato in conformità con lo standard Öko-Tex 100 IV, regolarmente controllato.  
Processo produttivo finalizzato a minimizzare l'impatto sull'ambiente e sulle risorse naturali.

### ENVIRONMENTAL INFORMATION

This fabric is manufactured without the addition of substances that might be a health hazard such as formaldehyde, CFC, solvents, lead/cadmium/quicksilver compounds.  
This product is PVC-free. It is certified in accordance with the Öko-Tex Standard 100 IV and is regularly monitored.  
The entire manufacturing process is designed to minimise any impact on the environment and natural resources.



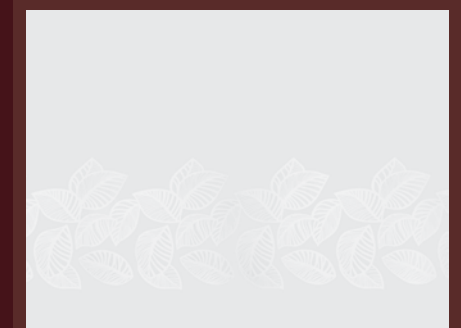

JM420079-1/200



JM420079-3/200

TANGERI  
collection

